

General Biology Road Map

2026-2027

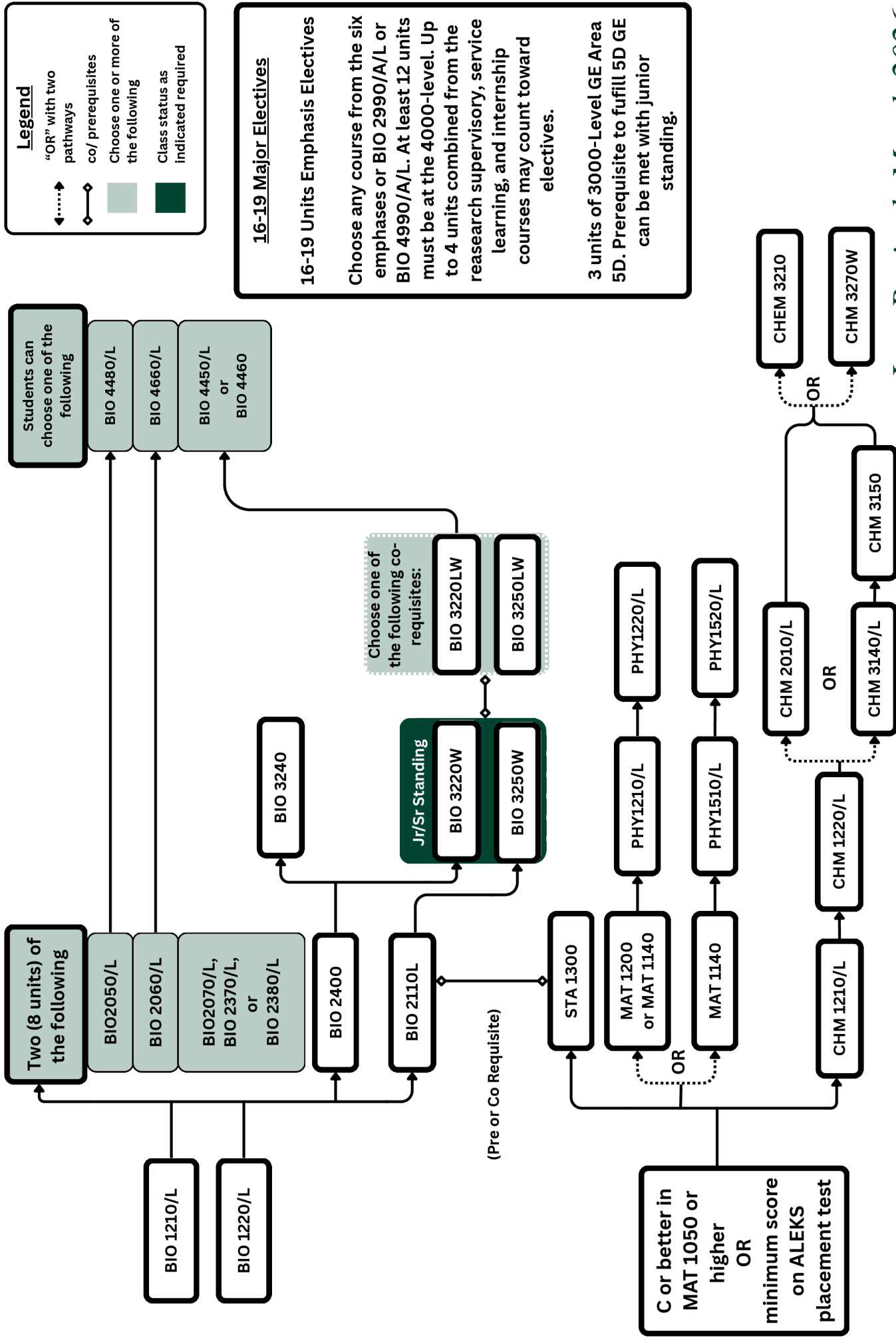

Science Educational Enhancement Services (SEES)



Last Revised: March 2026

General Biology

Prerequisite Level 0

- BIO 1210/L
 - BIO 1220/L
 - C or better in MAT 1050 or higher OR minimum score on ALEKS placement test
- ## Prerequisite Level 1
- BIO 2110L
Requires BIO 1210/L and BIO 1220/L, pre- or co-requisite STA 1300
 - Two (8 units) of the following:
BIO 2050/L, BIO 2060/L, and BIO 2070/L, BIO 2370/L, or BIO 2380/L
Requires BIO 1210/L and BIO 1220/L
 - BIO 2400
Requires BIO 1210/L and BIO 1220/L
 - CHM 1210/L
Requires C or better in MAT 1050 or higher OR minimum score on ALEKS placement test
 - MAT 1140 or MAT 1200
Requires C or better in MAT 1050 or higher OR minimum score on ALEKS placement test

Prerequisite Level 3

- Choose one of the following:
BIO 4480/L, BIO 4660/L, or BIO 4450/L or BIO 4460
BIO 4480/L requires BIO 2050/L
BIO 4660/L requires BIO 2060/L
BIO 4450/L or BIO 4460 requires BIO 3220LW
- CHM 2010/L or CHM 3140/L
Requires CHM 1220/L
- PHY 1220/L or PHY 1520/L
Requires PHY 1210/L or PHY 1510/L

Other Courses

- 16-19 Major Electives
- 16-19 Units Emphasis Electives
Choose any course from the six emphases or BIO 2990/A/L or BIO 4990/A/L. At least 12 units must be at 4000-level. Up to 4 units combined from the research supervisory, service learning, and internship courses may count toward electives.
- 3 Units of 3000-Level GE Area 5D
Prerequisite to fulfill 5D GE can be met with junior standing.

Prerequisite Level 4

- (CHM 3150)
Only if not taking CHM 2010/L
Requires CHM 3140/L

Prerequisite Level 5

- CHM 3210 or CHM 3270W
Requires CHM 2010/L or CHM 3150

Prerequisite Level 2

- BIO 3220W
Requires BIO 2400 and Junior/Senior standing, co-requisite BIO 3220LW
- BIO 3250W
Requires BIO 2110L and Junior/Senior standing, co-requisite BIO 3250LW
- BIO 3240
Requires BIO 2400
- CHM 1220/L
Requires CHM 1210/L
- PHY 1210/L or PHY 1510/L
Requires MAT 1140 or MAT 1200
- BIO 3220W
Co-requisite BIO 3220LW*
- BIO 3250W
Co-requisite BIO 3250LW*
*Students do not need to take both BIO 3220LW or 3250LW, only one of the two lab courses is needed to satisfy requirements.

Biotechnology Road Map

2026-2027



Science Educational
Enhancement Services
(SEES)

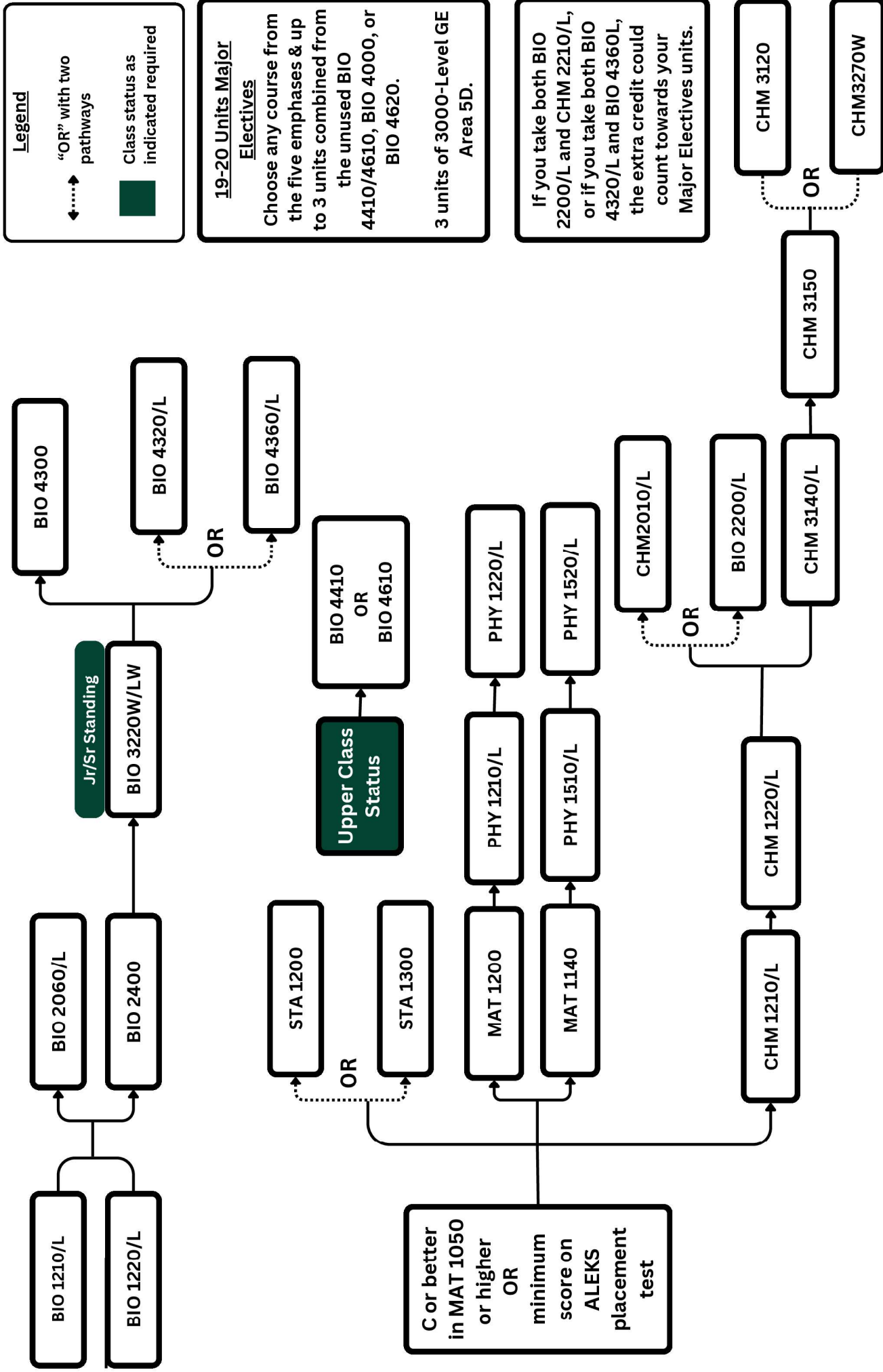

Last Revised: March 2026

Biotechnology

Prerequisite Level 0

- BIO 1210/L
- BIO 1220/L
- C or better in MAT 1050 or higher OR minimum score on ALEKS placement test

Prerequisite Level 1

- BIO 2060/L
Requires BIO 1210/L and BIO 1220/L
- BIO 2400
Requires BIO 1210/L and BIO 1220/L
- BIO 4410 or BIO 4610
Requires upper class status
- CHM 1210/L
Requires C or better in MAT 1050 or higher OR minimum score on ALEKS placement test
- MAT 1140 or MAT 1200
Requires C or better in MAT 1050 or higher OR minimum score on ALEKS placement test

Prerequisite Level 2

- BIO 3220W/LW
Requires BIO 2400 and Junior/Senior standing
- PHY 1210/L or PHY 1510/L
Requires MAT 1200 or MAT 1140
- CHM 1220/L
Requires CHM 1210/L

Prerequisite Level 3

- BIO 4300
Requires BIO 3220W/LW
- BIO 4320/L or BIO 4360/L
Requires BIO 3220W/LW
- PHY 1220/L or PHY 1520/L
Requires PHY 1210/L or PHY 1510/L
- CHM 2010/L or BIO 2200/L
Requires CHM 1220/L
- CHM 3140/L
Requires CHM 1220/L

Prerequisite Level 4

- CHM 3150
Requires CHM 3140/L

Prerequisite Level 5

- CHM 3120 or CHM 3270W
Requires CHM 3150

Other Courses

- 19-20 Units Major Electives
Choose any course from the five emphases & up to 3 units combined from the unused BIO 4410/4610, BIO 4000, or BIO 4620.
- 3 units of 3000-Level GE Area 5D
- If you take both BIO 2200/L and CHM 2210/L, or if you take both BIO 4320/L and BIO 4360L, the extra credit could count towards your Major Electives units.

Environmental Biology Road Map

2026-2027



Science Educational Enhancement Services (SEES)

32-34 Major Electives

14-15 Units Lower Division Elective Courses

17-19 Units Upper Division Emphasis Elective Courses

Legend

“OR” with two pathways

co/ prerequisites

Choose one or more of the following

Class status as indicated required

0-9 Units Unrestricted Electives

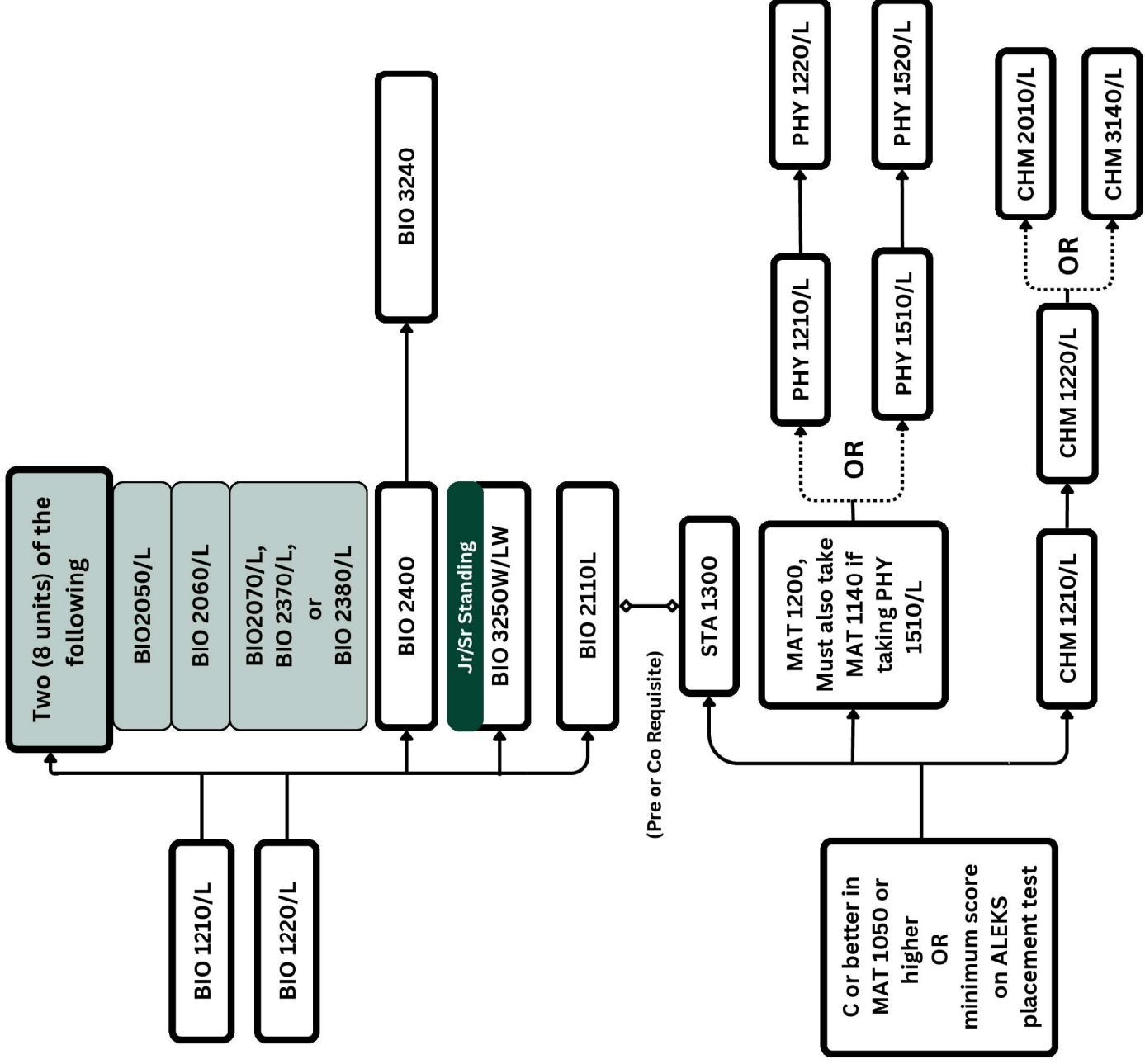

Last Revised: March 2026

Environmental Biology

Prerequisite Level 0

- BIO 1210/L
- BIO 1220/L
- C or better in MAT 1050 or higher OR minimum score on ALEKS placement test

Prerequisite Level 1

- Two (8 units) of the following:
 - BIO 2050/L, BIO 2060/L, and BIO 2070/L, BIO 2370/L, or BIO 2380/L
 - Requires BIO 1210/L and BIO 1220/L

- BIO 2110L

Requires BIO 1210/L and BIO 1220/L, pre- or co-requisite STA 1300

- BIO 2400
 - Requires BIO 1210/L and BIO 1220/L
- BIO 3250W/LW
 - Requires BIO 1210/L and BIO 1220/L and Junior/Senior standing
- STA 1300

Requires C or better in MAT 1050 or higher OR minimum score on ALEKS placement test

- MAT 1200, must also take MAT 1140 if taking PHY 1510/L

Requires C or better in MAT 1050 or higher OR minimum score on ALEKS placement test

- CHM 1210/L

Requires C or better in MAT 1050 or higher OR minimum score on ALEKS placement test

- BIO 3040 or BIO 3120 (B5/5D)

Requires Junior standing

- RS 3020 (D4/4C)

Requires junior standing

- BIO 4410, BIO 4610, or BIO 4910S

Requires upper class status

Prerequisite Level 2

- BIO 3240

Requires BIO 2400

- CHM 1220/L

Requires CHM 1210/L

- PHY 1210/L or PHY 1510/L

Requires MAT 1200 or MAT 1140

Prerequisite Level 3

- CHM 2010/L or CHM 3140/L

Requires CHM 1220/L

- PHY 1220/L or PHY 1520/L

Requires PHY 1210/L or PHY 1510/L

Other Courses

- 32-34 Major Electives
- 14-15 Units Lower Division Elective Courses
- 17-19 Units Upper Division Emphasis Elective Courses
- 0-9 Units Unrestricted Electives

Chemistry: ACS Road Map

2026-2027



Science Educational
Enhancement Services
(SEES)

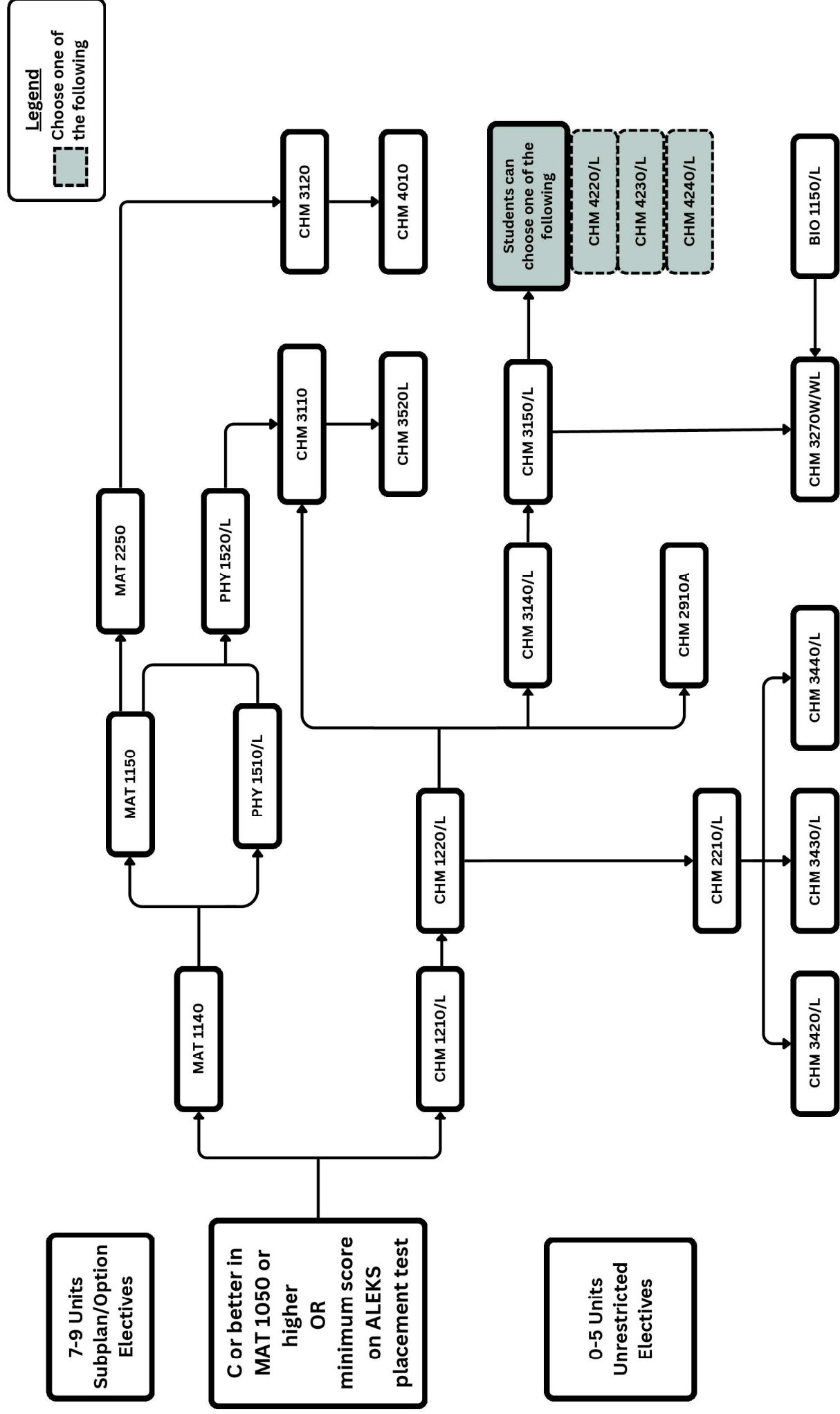

Last Revised: April 2026

Chemistry: ACS

Prerequisite Level 0

- C or better in MAT 1050 or higher OR minimum score on ALEKS placement test
- BIO 1150/L

Prerequisite Level 1

- CHM 1210/L
Requires C or better in MAT 1050 or higher OR minimum score on ALEKS placement test
- MAT 1140
Requires C or better in MAT 1050 or higher OR minimum score on ALEKS placement test

- CHM 1220/L
Requires CHM 1210/L
- MAT 1150
Requires MAT 1140

Prerequisite Level 2

- CHM 1220/L
Requires CHM 1210/L
- MAT 1150
Requires MAT 1140
- PHY 1510/L
Requires MAT 1140

Prerequisite Level 3

- CHM 2210/L
Requires CHM 1220/L
- CHM 2910A
Requires CHM 1220/L
- CHM 3140/L
Requires CHM 1220/L
- PHY 1520/L
Requires MAT 1150 and PHY 1510/L
- MAT 2250
Requires MAT 1150

Prerequisite Level 4

- CHM 3120
Requires MAT 2250
- CHM 3110
Requires CHM 1220/L and PHY 1520/L
- CHM 3150/L
Requires CHM 3140/L
- CHM 3420/L
Requires CHM 2210/L
- CHM 3430/L
Requires CHM 2210/L
- CHM 3440/L
Requires CHM 2210/L

Prerequisite Level 5

- CHM 3520L
Requires CHM 3110
- CHM 3270W/WL
Requires CHM 3150/L and BIO 1150/L
- CHM 4010
Requires CHM 3120
- Choose one of the following: CHM 4220/L, CHM 4230/L, or CHM 4240/L
Requires CHM 3150/L

Other Courses

- 7-9 Units Subplan/Option Electives
- 0-5 Units Unrestricted Electives

Chemistry: Biochemistry Road Map

2026-2027



Science Educational
Enhancement Services
(SEES)

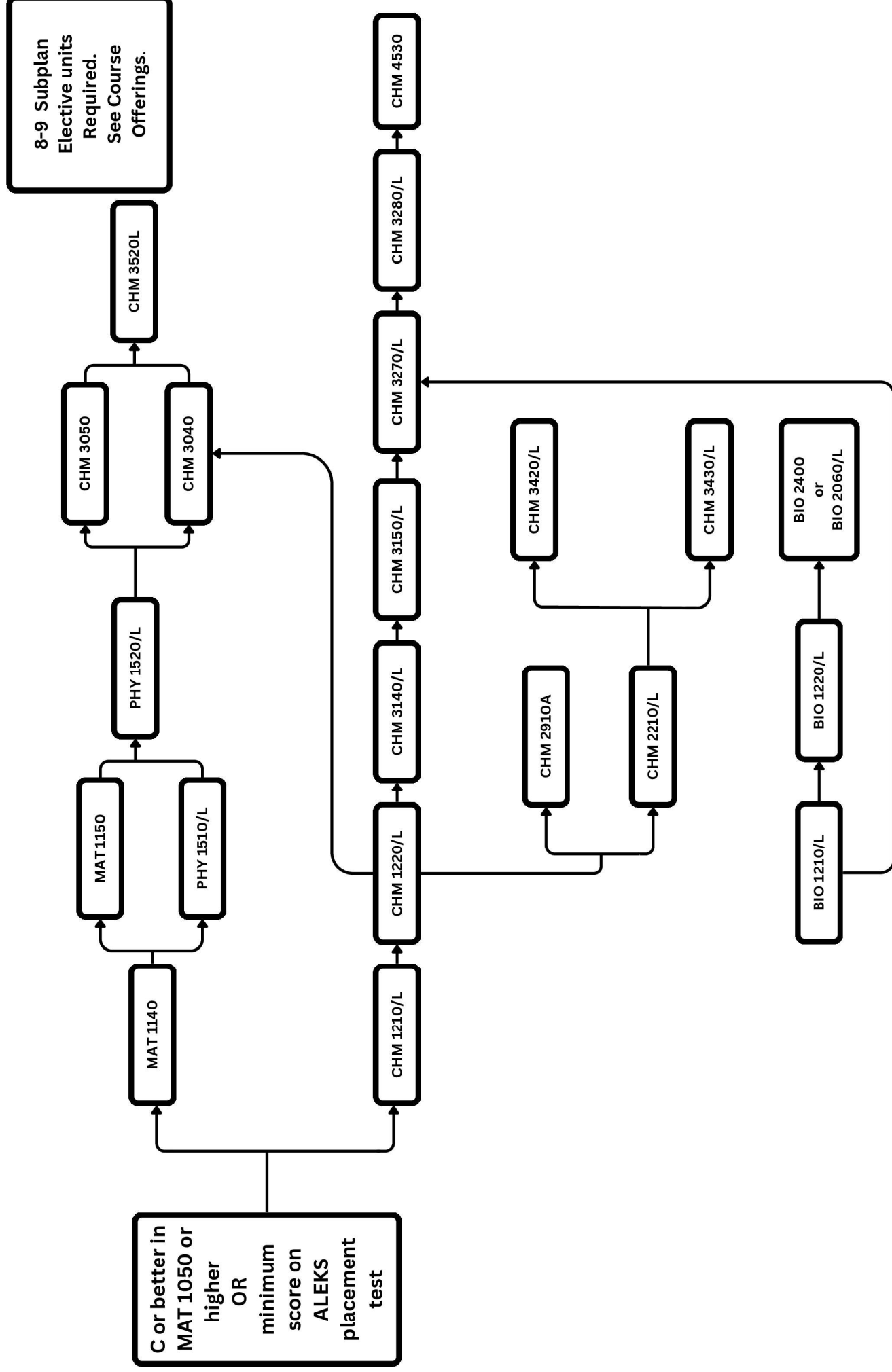

Last Revised: March 2026

Chemistry: Biochemistry

Prerequisite Level 0

- BIO 1210/L
- C or better in MAT 1050 or higher OR minimum score on ALEKS placement test

Prerequisite Level 1

- BIO 1220/L
Requires BIO 1210/L
- CHM 1210/L
Requires C or better in MAT 1050 or higher OR minimum score on ALEKS placement test

- MAT 1140
Requires C or better in MAT 1050 or higher OR minimum score on ALEKS placement test

Prerequisite Level 2

- BIO 2060/L or BIO 2400
Requires BIO 1220/L
- CHM 1220/L
Requires CHM 1210/L
- MAT 1150
Requires MAT 1140
- PHY 1510/L
Requires MAT 1140

Prerequisite Level 3

- CHM 2210/L
Requires CHM 1220/L
- CHM 2910A
Requires CHM 1220/L
- CHM 3140/L
Requires CHM 1220/L
- PHY 1520/L
Requires MAT 1150 and PHY 1510/L

Prerequisite Level 4

- CHM 3040
Requires CHM 1220/L and PHY 1520/L
- CHM 3050
Requires PHY 1520/L
- CHM 3150/L
Requires CHM 3140/L
- CHM 3420/L
Requires CHM 2210/L
- CHM 3430/L
Requires CHM 2210/L

Prerequisite Level 5

- CHM 3520L
Requires CHM 3040 and CHM 3050
- CHM 3270/L
Requires BIO 1210/L and CHM 3150/L

Prerequisite Level 6

- CHM 3280/L
Requires CHM 3270/L

Prerequisite Level 7

- CHM 4530
Requires CHM 3280/L

Other Courses

- 8-9 Subplan Elective units required
See course offerings

General Chemistry Road Map

2026-2027



Science Educational
Enhancement Services
(SEES)

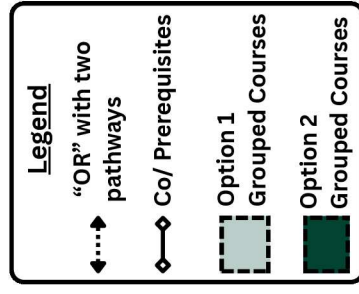

*Either Option 1 or 2 can be used to meet requirements. C or Better in CHM 1220 is also pre-requisite for all courses in Option 1 or 2.

(Pre or Co Requisite, Only Required if Taking CHM 3120)

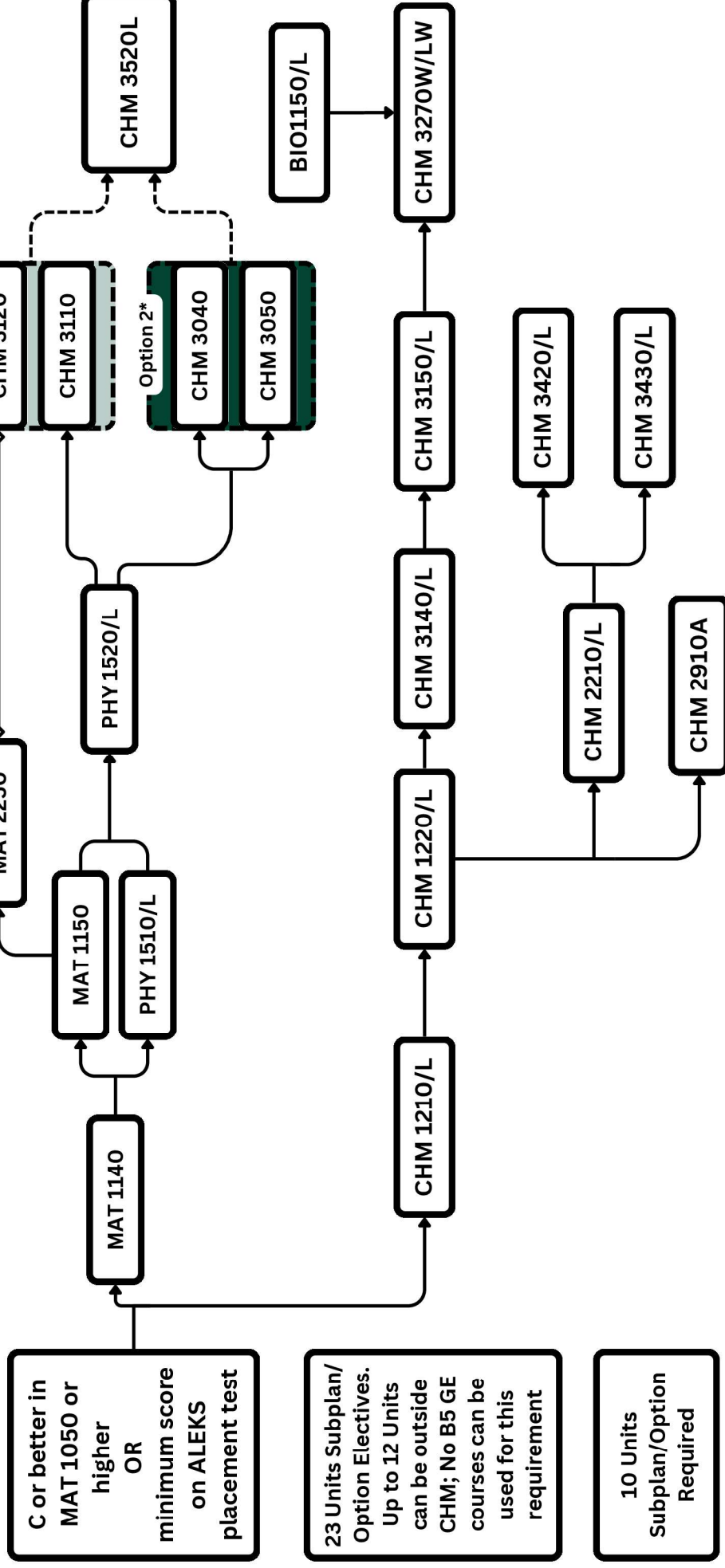

C or better in MAT 1050 or higher OR minimum score on ALEKS placement test

23 Units Subplan/
Option Electives.
Up to 12 Units can be outside CHM; No B5 GE courses can be used for this requirement

10 Units Subplan/
Option Required

Chemistry: General

Prerequisite Level 0

- C or better in MAT 1050 or higher OR minimum score on ALEKS placement test
- BIO 1150/L

Prerequisite Level 1

- CHM 1210/L
Requires C or better in MAT 1050 or higher OR minimum score on ALEKS placement test
- MAT 1140
Requires C or better in MAT 1050 or higher OR minimum score on ALEKS placement test

Prerequisite Level 3

- CHM 2210/L
Requires CHM 1220/L
- CHM 2910A
Requires CHM 1220/L
- CHM 3140/L
Requires CHM 1220/L
- PHY 1520/L
Requires MAT 1150 and PHY 1510/L
- MAT 2250
Requires MAT 1150, only required if taking CHM 3120
- *Option 1: CHM 3120
Requires CHM 1220, pre- or co-requisite MAT 2250

Prerequisite Level 4

- CHM 3150/L
Requires CHM 3140/L
- CHM 3420/L
Requires CHM 2210/L
- CHM 3430/L
Requires CHM 2210/L
- *Option 1: CHM 3110
Requires PHY 1520/L and CHM 1220
- *Option 2: CHM 3040 and CHM 3050
Requires PHY 1520/L and CHM 1220

Prerequisite Level 5

- CHM 3520L
Requires CHM 3120, CHM 3110, CHM 3040, or CHM 3050
- CHM 3270W/LW
Requires CHM 3150/L and BIO 1150/L

Other Courses

- 23 Units Subplan/Option Electives
Up to 12 units can be outside CHM; No B5 GE courses can be used for this requirement
- 10 Units Subplan/Option Required
- *Either Option 1 or 2 can be used to meet requirements. C or better in CHM 1220 is also pre-requisite for all courses in Option 1 or 2

Computer Science Road Map

2026-2027



Science Educational
Enhancement Services
(SEES)

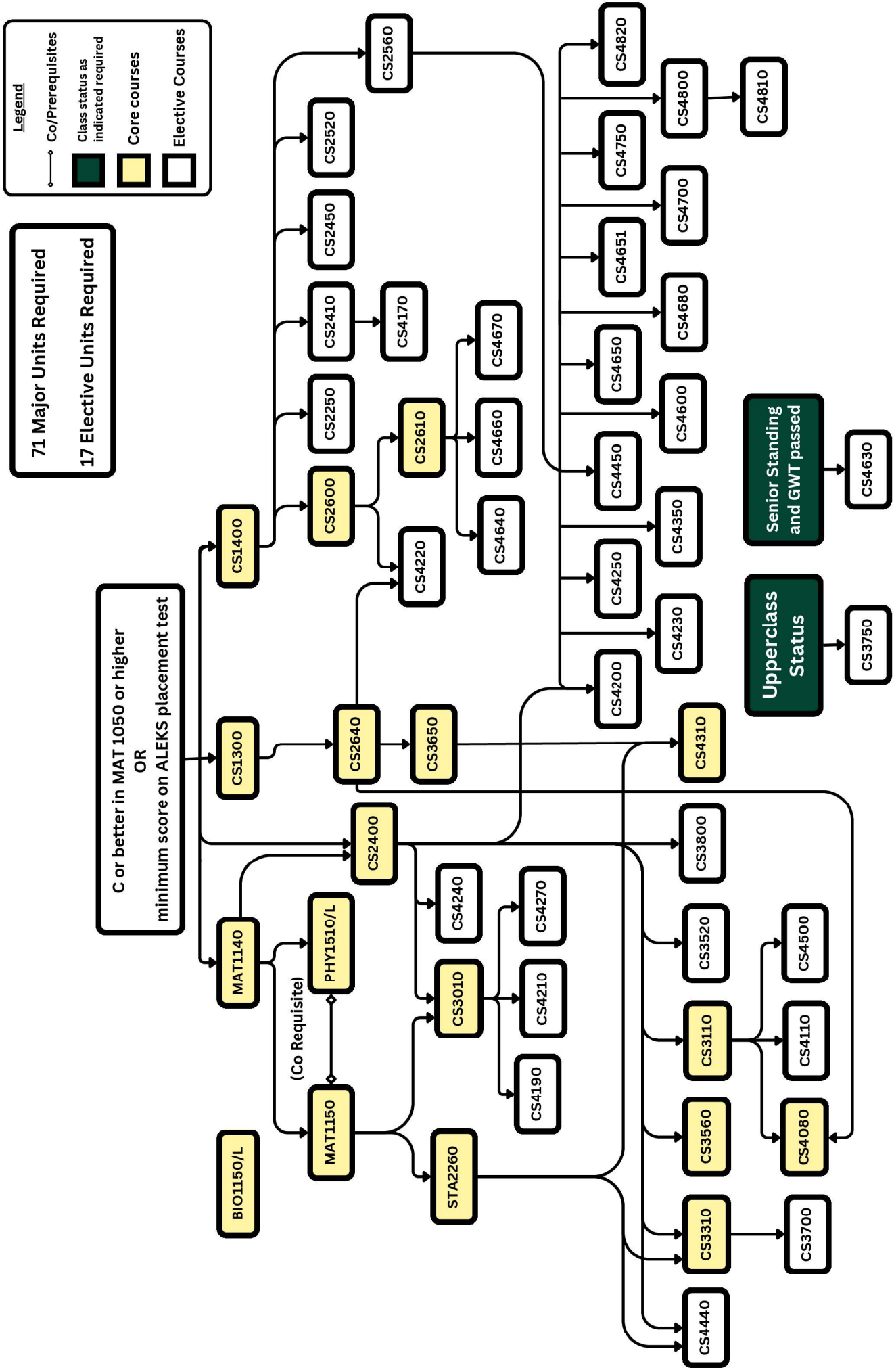

Last Revised: March 2026

Computer Science

Prerequisite Level 0

- BIO 1110/L
- C or better in MAT 1050 or higher OR minimum score on ALEKS placement test

Requires CS 1400

- CS 2640
- Requires CS 1300
- MAT 1150

Requires MAT 1140, co-requisite PHY 1510/1510L

- PHY 1510/1510L

Requires MAT 1140, co-requisite MAT 1150

- CS 4250
- Requires CS 4200
- CS 4350
- Requires CS 2400
- CS 4450
- Requires CS 2400 and CS 2560

- Requires CS 2400
- CS 4220
- Requires CS 2600 and CS 2640

Prerequisite Level 4

- CS 4110
- Requires CS 3110
- CS 4210
- Requires CS 3010
- CS 4190
- Requires CS 3010
- CS 4270
- Requires CS 3010
- CS 4440
- Requires CS 2400 and STA 2260
- CS 4500
- Requires CS 3110
- CS 4810
- Requires CS 4800

Electives

Prerequisite Level 2

- CS 2250
- Requires CS 1400
- CS 2410
- Requires CS 1400
- CS 2450
- Requires CS 1400
- CS 2520
- Requires CS 1400
- CS 2560
- Requires CS 1400

Prerequisite Level 3

- CS 2610
- Requires CS 2600
- CS 3010
- Requires CS 2400 and MAT 1140
- CS 3110
- Requires CS 2400
- CS 3560
- Requires CS 2400
- CS 3650
- Requires CS 2640
- STA 2260
- Requires MAT 1150

- CS 1300
- Requires eligibility for MAT 1140
- CS 1400
- Requires eligibility for MAT 1140
- MAT 1140
- Requires eligibility for MAT 1140
- CS 3750
- Requires upperclass standing
- CS 4630
- Requires senior standing and GWT passed

Prerequisite Level 1

- CS 1300
- Requires eligibility for MAT 1140
- CS 1400
- Requires eligibility for MAT 1140
- MAT 1140
- Requires eligibility for MAT 1140
- CS 3750
- Requires upperclass standing
- CS 4630
- Requires senior standing and GWT passed

Prerequisite Level 2

- CS 2400
- Requires CS 1300, CS 1400, and MAT 1140
- CS 2600
- CS 4080

Prerequisite Level 4

- CS 4200
- Requires CS 2400
- CS 4230
- Requires CS 2400

Other Courses

- 71 Major Units Required
- 17 Elective Units Required

Geological Sciences Road Map

2026-2027



Science Educational
Enhancement Services
(SEES)

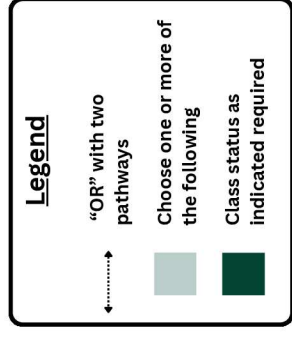

4 Units Restricted Courses

4 Units Elective courses

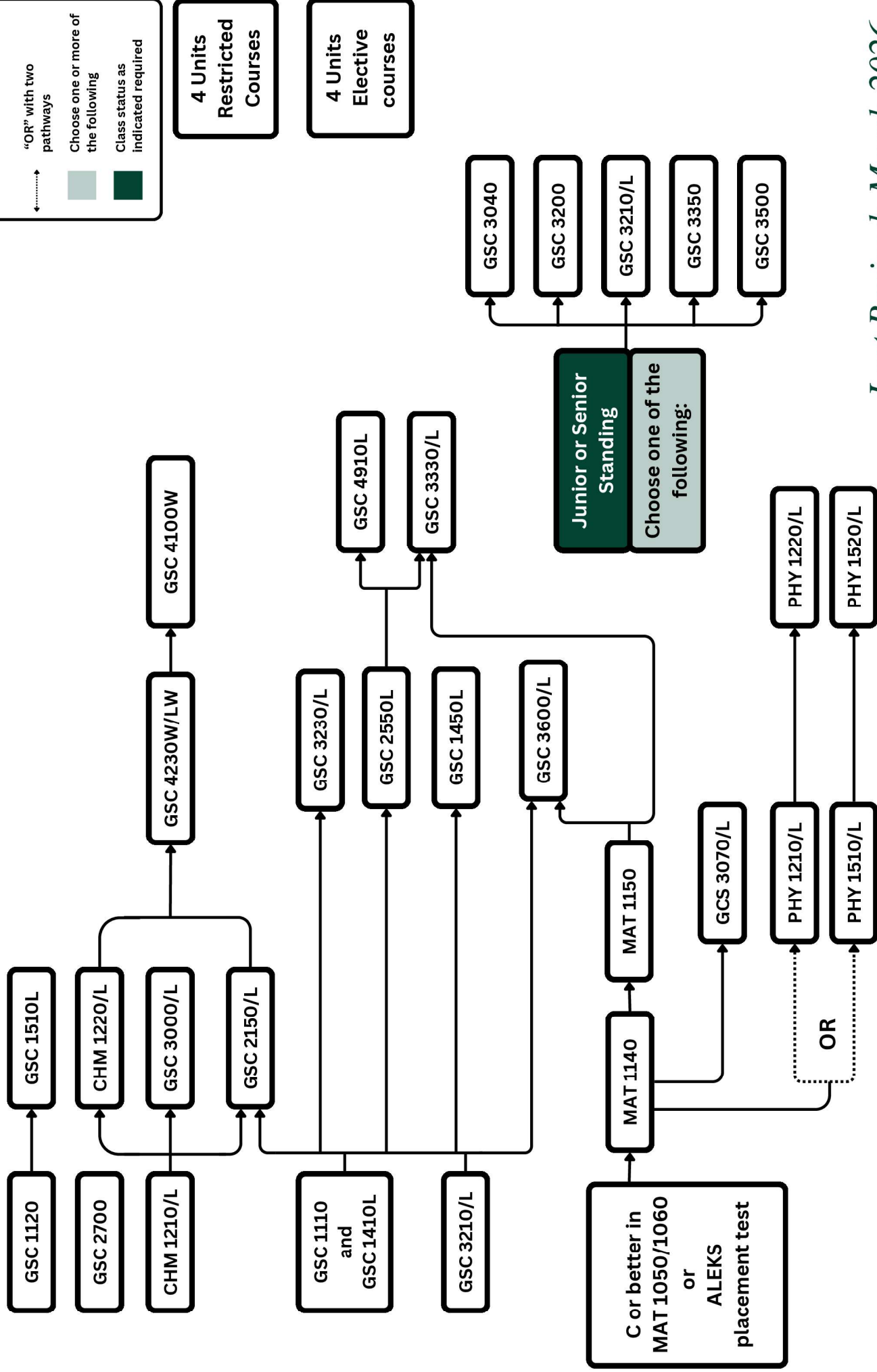

Last Revised: March 2026

Geological Sciences

Prerequisite Level 0

- C or better in MAT 1050/1060 OR ALEKS Placement Test

Prerequisite Level 1

- GSC 1120
- GSC 2700
- CHM 1210/L
- GSC 1110
- GSC 1410L
- GSC 3210/L

Prerequisite Level 2

- MAT 1140
- GSC 1510L
Requires GSC 1120
- CHM 1220/L
Requires CHM 1210/L
- GSC 3000/L
Requires CHM 1210/L
- GSC 2150/L
Requires GSC 1110, GSC 1410/L, and GSC 3210/L
- GSC 3230/L
Requires GSC 1110, GSC 1410/L, and GSC 3210/L
- GSC 2550/L
Requires GSC 1110, GSC 1410/L, and GSC 3210/L

Prerequisite Level 3

- MAT 1150
Requires MAT 1140
- PHY 1210/L OR PHY 1510/L
Requires MAT 1140
- GSC 3070/L
Requires MAT 1140
- GSC 4230W/LW

Prerequisite Level 4

- GSC 4100W
Requires GSC 4230W/LW
- GSC 4910L
Requires GSC 2550L
- GSC 3330/L
Requires GSC 2550L AND MAT 1150
- GSC 3600/L
Requires GSC 3210/L AND MAT 1150
- PHY 1220/L OR PHY 1520/L
Requires PHY 1210/L and PHY 1510/L respectively

Prerequisite Level 5

- GSC 3040
Requires Junior or Senior Standing
- GSC 3200
Requires Junior or Senior Standing
- GSC 3210/L
Requires Junior or Senior Standing
- GSC 3350
Requires Junior or Senior Standing
- GSC 3500
Requires Junior or Senior Standing

Other Courses

- 4 Units Restricted (Prerequisite Level 5) Courses
- 4 Units Elective courses.

Kinesiology: General Road Map

2026-2027



Science Educational
Enhancement Services
(SEES)

Legend
Class status as indicated required

23 Units
Subplan/Option
Electives

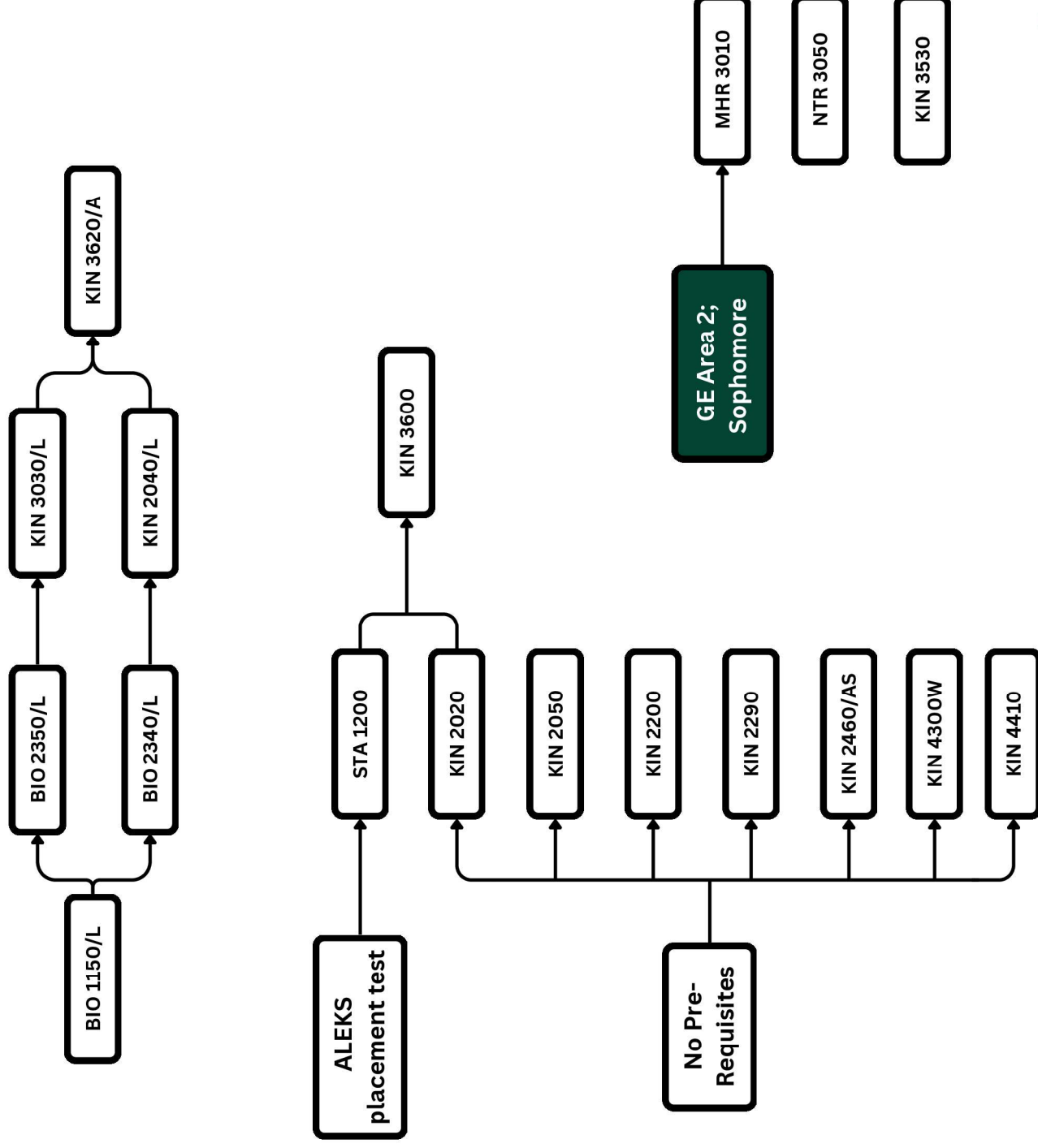

Last Revised: March 2026

Kinesiology: General

Prerequisite Level 0

- ALEKS Placement Test

Prerequisite Level 1

- BIO 1150/L
- KIN 2020
- KIN 2050
- KIN 2200
- KIN 2230
- KIN 2460/AS
- KIN 2290
- KIN 4300
- KIN 4450
- NTR 3050

Prerequisite Level 2

- STA 1200
Requires minimum score on ALEKS placement test
- BIO 2350/L
Requires BIO 1150/L
- BIO 2340/L
Requires BIO 1150/L

Prerequisite Level 3

- KIN 3030/L
Requires BIO 2350/L
- KIN 2040/L
Requires BIO 2340/L
- KIN 3100/A
Requires KIN 2220, KIN 2230, KIN 2460/A
- KIN 3110/A
Requires KIN 2220, KIN 2230, KIN 2460/A
- KIN 3120/A
Requires KIN 2220, KIN 2230, KIN 2460/A
- KIN 3130/A
Requires KIN 2220, KIN 2230, KIN 2460/A
- KIN 3140/A
Requires KIN 2220, KIN 2230, KIN 2460/A
- KIN 3460/A
Requires KIN 2220, KIN 2230, KIN 2460/A

Prerequisite Level 4

- KIN 4200
Requires all KIN classes from Level 3
- KIN 4620
Requires all KIN classes from Level 3
- KIN 4330/A
Requires KIN 3460/A

Other Courses

- 0-13 Units Subplan/Option Electives
- 0-4 Units Unrestricted Electives

Kinesiology: Physical Education Teacher Education Road Map_

2026-2027

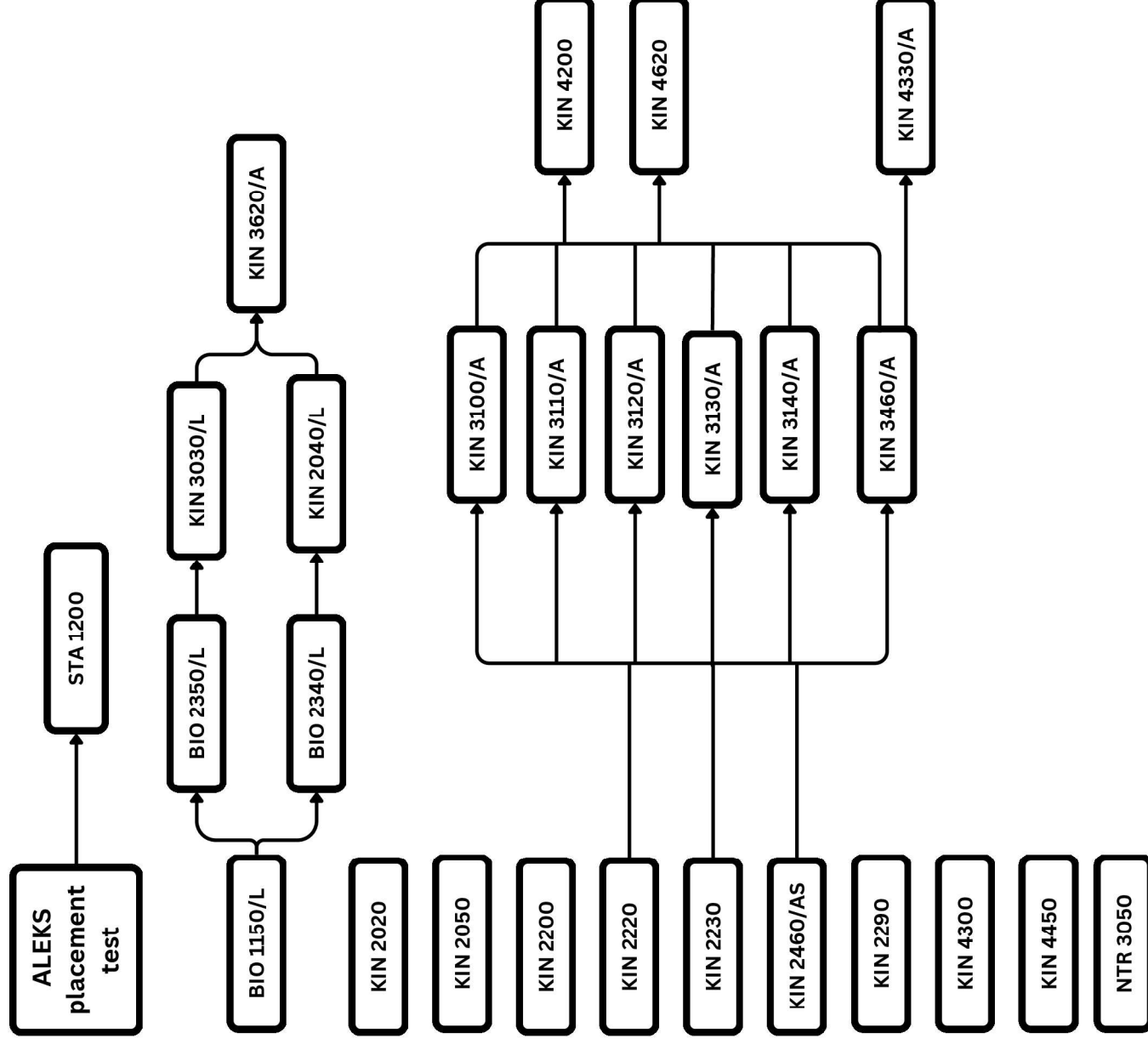

0-4 Units
Unrestricted
Electives

0-13
Subplan/Option
Electives

Kinesiology: Physical Education Teacher

Prerequisite Level 0

- ALEKS Placement Test

Prerequisite Level 1

- BIO 1150/L
- KIN 2020
- KIN 2050
- KIN 2200
- KIN 2230
- KIN 2460/AS
- KIN 2290
- KIN 4300
- KIN 4450
- NTR 3050

Prerequisite Level 2

- STA 1200
Requires minimum score on ALEKS placement test
- BIO 2350/L
Requires BIO 1150/L
- BIO 2340/L
Requires BIO 1150/L

Prerequisite Level 3

- KIN 3030/L
Requires BIO 2350/L
- KIN 2040/L
Requires BIO 2340/L
- KIN 3100/A
Requires KIN 2220, KIN 2230, KIN 2460/A
- KIN 3110/A
Requires KIN 2220, KIN 2230, KIN 2460/A
- KIN 3120/A
Requires KIN 2220, KIN 2230, KIN 2460/A
- KIN 3130/A
Requires KIN 2220, KIN 2230, KIN 2460/A
- KIN 3140/A
Requires KIN 2220, KIN 2230, KIN 2460/A
- KIN 3460/A
Requires KIN 2220, KIN 2230, KIN 2460/A

Prerequisite Level 4

- KIN 4200
Requires all KIN classes from Level 3
- KIN 4620
Requires all KIN classes from Level 3
- KIN 4330/A
Requires KIN 3460/A

Other Courses

- 0-13 Units Subplan/Option Electives
- 0-4 Units Unrestricted Electives

Mathematics Road Map

2026-2027



Science Educational
Enhancement Services
(SEES)

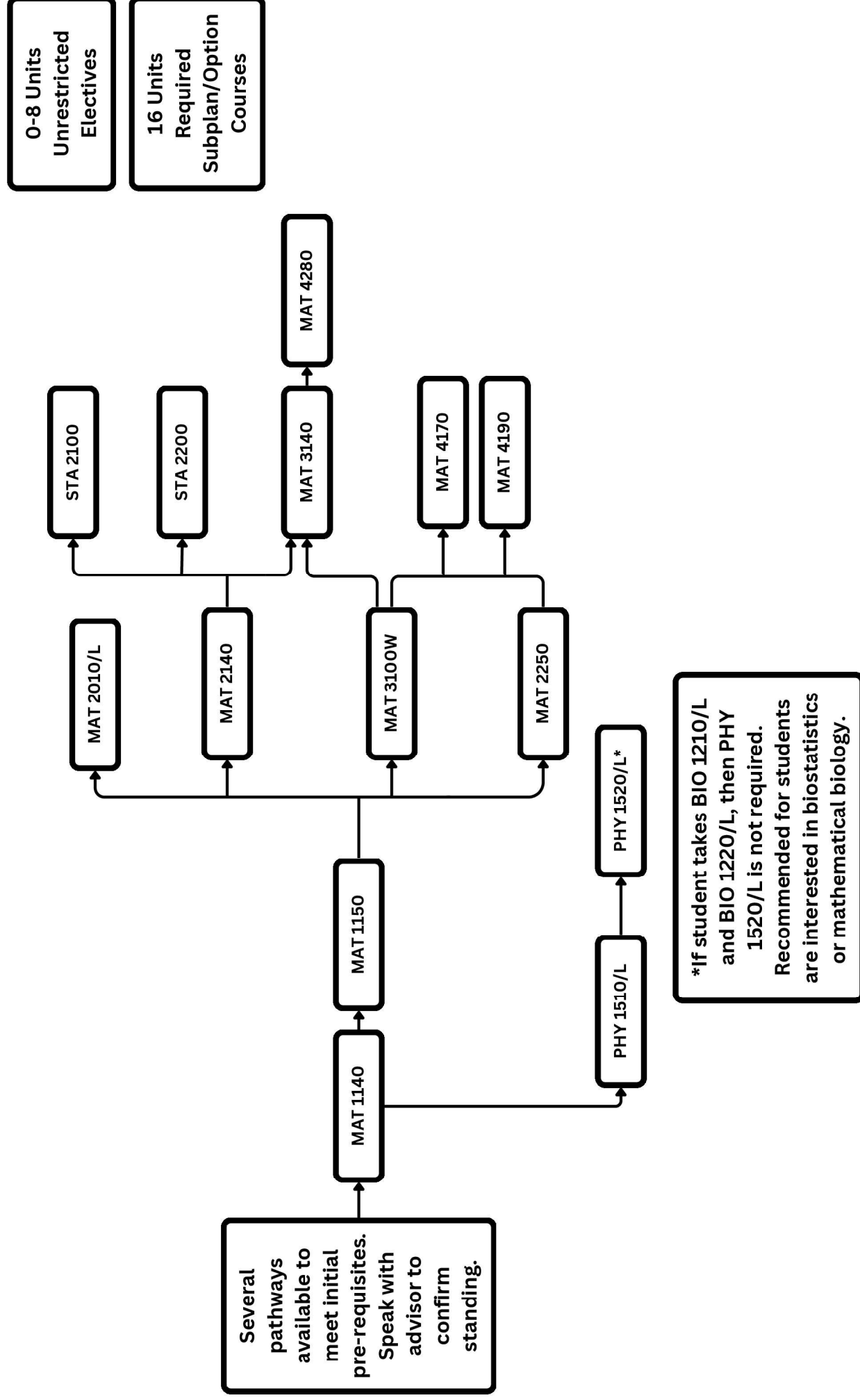

Mathematics

Prerequisite Level 0

- Several pathways available to meet initial pre-requisites. Speak with advisor to confirm standing.

Prerequisite Level 1

- **MAT 1140**
Requires C or better in MAT 1050 & MAT 1060 OR minimum score on ALEKS placement test

Prerequisite Level 2

- **MAT 1150**
Requires C or better in MAT 1140 OR minimum score on ALEKS placement test
- **PHY 1510/L**
Requires MAT 1140 or MAT 1200

Prerequisite Level 3

- **MAT 2010/L**
- **MAT 2140**
Requires MAT 1150
- **MAT 3100W**
Requires MAT 1150
- **MAT 2250**
Requires MAT 1150
- **PHY 1520/L**
Requires PHY 1510/L. If a student takes BIO 1210/L and BIO 1220/L, then PHY 1520/L is not required.

Prerequisite Level 4

- **STA 2100**
Requires MAT 2140
- **STA 2200**
Requires MAT 2140
- **MAT 3140**
Requires MAT 2140 AND MAT 3100W
- **MAT 4170**
Requires MAT 3100W AND MAT 2250
- **MAT 4190**
Requires MAT 3100W AND MAT 2250

Prerequisite Level 5

- **MAT 4280**
Requires MAT 3140

Other Courses

- 16 Units Subplan/Option Electives
- 0-8 Units Unrestricted Electives

Physics: Biophysics Road Map

2026-2027



Science Educational
Enhancement Services
(SEES)

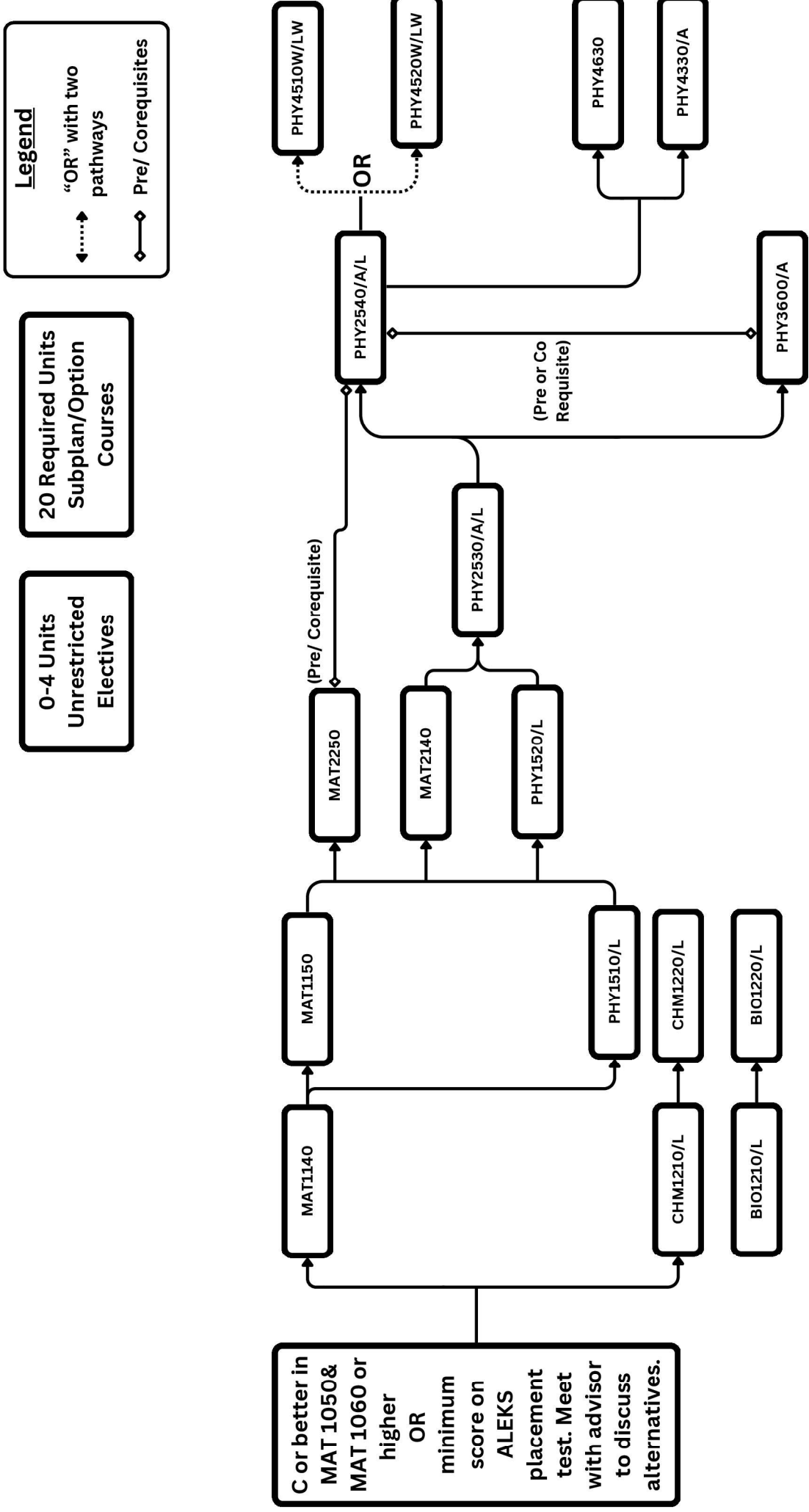

0-4 Units
Unrestricted
Electives

20 Required Units
Subplan/Option
Courses

Physics: Biophysics

Prerequisite Level 0

- C or better in MAT 1050 & MAT 1060 or higher OR minimum score on ALEKS placement test

Prerequisite Level 1

- CHM 1210/L
Requires C or better in MAT 1050 & MAT 1060 OR minimum score on ALEKS placement test
- MAT 1140
Requires C or better in MAT 1050 & MAT 1060 OR minimum score on ALEKS placement test
- BIO 1210/L

Prerequisite Level 2

- BIO 1220/L
Requires BIO 1210/L
- CHM 1220/L
Requires CHM 1210/L
- MAT 1150
Requires C or better in MAT 1140 OR minimum score on ALEKS placement test
- PHY 1510/L
Requires MAT 1140 or MAT 1200

Prerequisite Level 3

- MAT 2250
Requires MAT 1150
- MAT 2140
Requires MAT 1150
- PHY 1520/L
Requires PHY 1510/L

Prerequisite Level 4

- PHY 2530/A/L
Requires MAT 2140 & PHY 1520/L

Prerequisite Level 5

- PHY 3600/A
Pre or Corequisite for PHY 2540
- PHY 2540/A/L
Pre or Corequisite for PHY 3600/A

Prerequisite Level 6

- PHY 4630
Requires PHY 2540/A/L
- PHY 4330
Requires PHY 2540/A/L
- PHY 4510W/LW OR PHY 4520W/LW
Requires PHY 2540/A/L

Other Courses

- 20 Units Subplan/Option Electives
- 0-4 Units Unrestricted Electives

General Physics Road Map

2026-2027



Science Educational
Enhancement Services
(SEES)

11 - 16 Units
Subplan/Option
Courses

0-10 Units
Unrestricted
Electives

*Students may take MAT 2010 and CS 1260 in order to meet requirements for PHY 3210/A, but MAT 2010 and CS 1260 are not major required courses.
PHY3600/A can also satisfy requirements for PHY 3210/A^

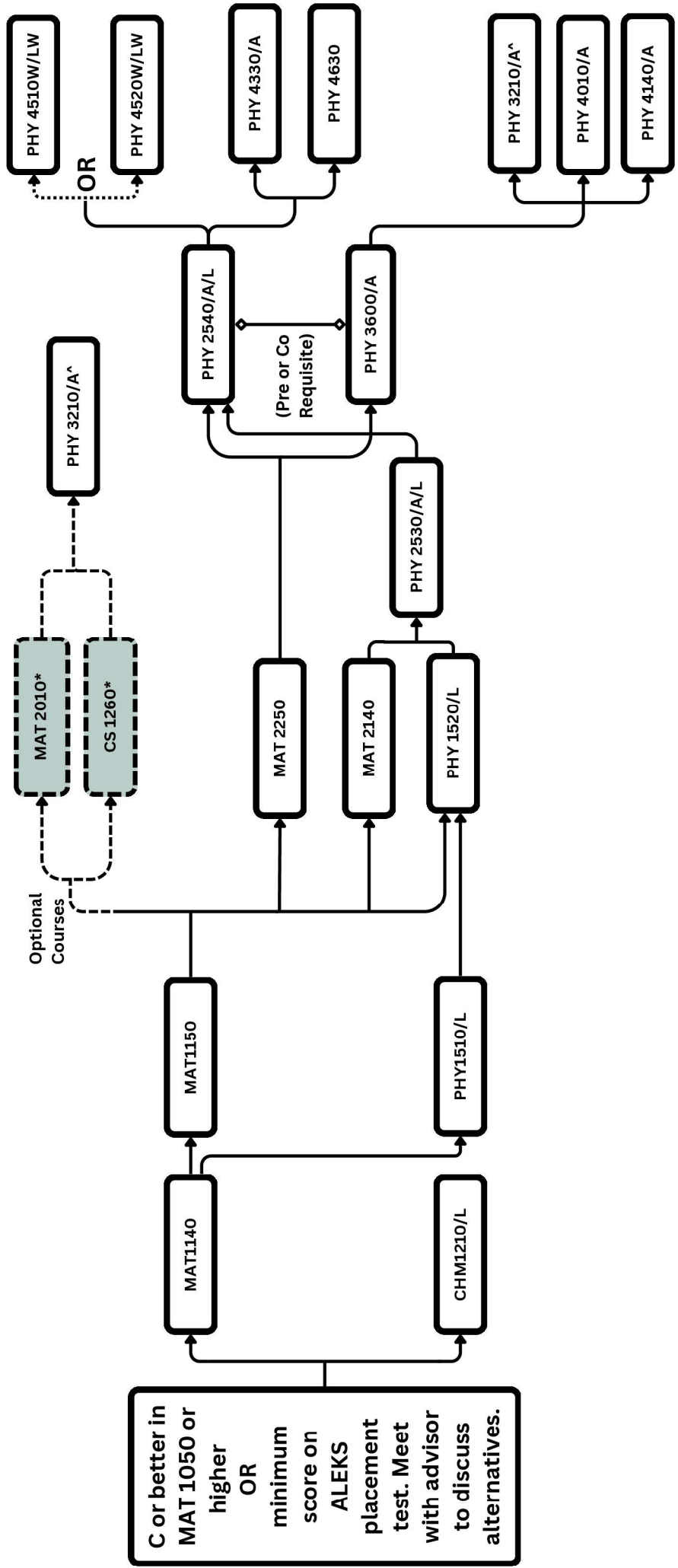
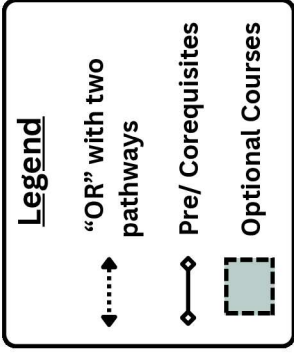

Physics: General

Prerequisite Level 0

- C or better in MAT 1050 & MAT 1060 or higher OR minimum score on ALEKS placement test

Prerequisite Level 1

- CHM 1210/L
Requires C or better in MAT 1050 & MAT 1060 OR minimum score on ALEKS placement test
- MAT 1140
Requires C or better in MAT 1050 & MAT 1060 OR minimum score on ALEKS placement test

Prerequisite Level 2

- MAT 1150
Requires C or better in MAT 1140 OR minimum score on ALEKS placement test
- PHY 1510/L
Requires MAT 1140 or MAT 1200

Prerequisite Level 3

- MAT 2250
Requires MAT 1150
- MAT 2140
Requires MAT 1150
- PHY 1520/L
Requires PHY 1510/L

Prerequisite Level 4

- PHY 2530/A/L
Requires MAT 2140 & PHY 1520/L
- PHY 3210/A
Requires MAT 2010 OR CS 1260 (optional)

Prerequisite Level 5

- PHY 3600/A
Pre or Corequisite for PHY 2540
- PHY 2540/A/L
Pre or Corequisite for PHY 3600/A

Prerequisite Level 6

- PHY 3210/A
Requires PHY 3600/A
- PHY 4010/A
Requires PHY 3600/A
- PHY 4140/A
Requires PHY 3600/A
- PHY 4630
Requires PHY 2540/A/L
- PHY 4330
Requires PHY 2540/A/L
- PHY 4510W/LW OR PHY 4520W/LW
Requires PHY 2540/A/L

Other Courses

- 11-16 Units Subplan/Option Electives
- 0-10 Units Unrestricted Electives

Physics: Integrated Science Road Map

2026-2027



Science Educational Enhancement Services (SEES)

16 Units Subplan/Option Electives

0-8 Units Unrestricted Electives

Legend
 "OR" with two pathways
 Co/ Prerequisites

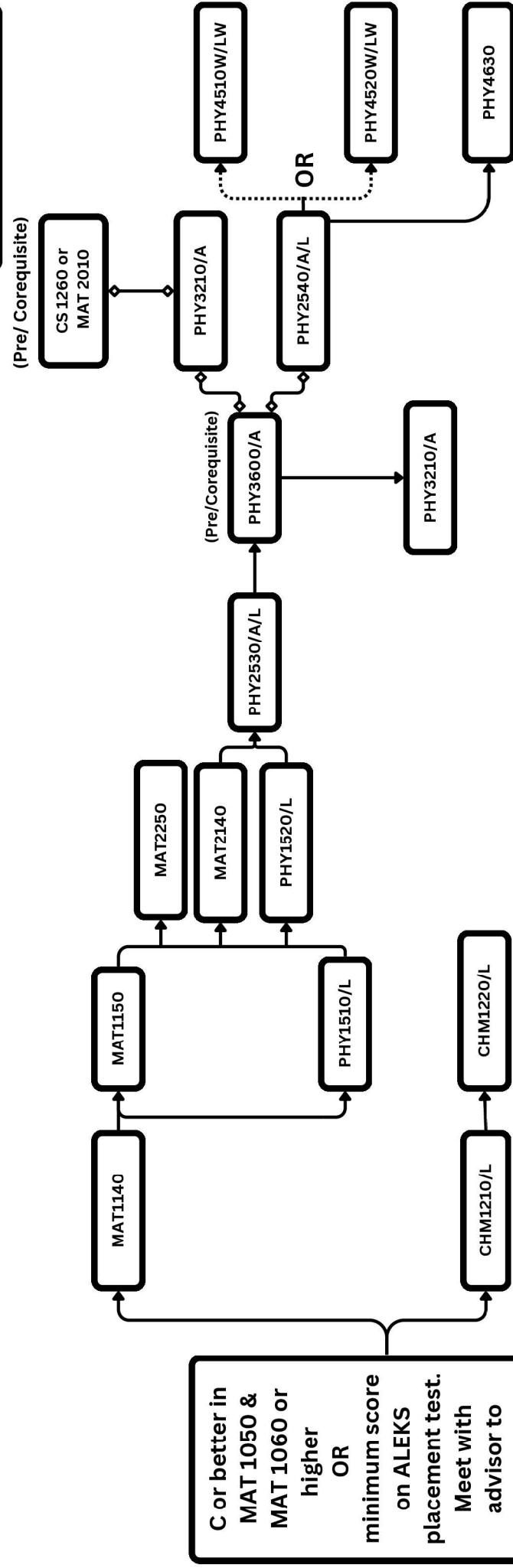

- BIO1210/L
- GSC1110
- GSC1160
- GSC1410L
- STS2010

Physics: Integrated Science

Prerequisite Level 0

- C or better in MAT 1050 & MAT 1060 or higher OR minimum score on ALEKS placement test

Prerequisite Level 1

- CHM 1210/L
Requires C or better in MAT 1050 & MAT 1060 OR minimum score on ALEKS placement test
- MAT 1140
Requires C or better in MAT 1050 & MAT 1060 OR minimum score on ALEKS placement test
- BIO 1210/L
- GSC 1110
- GSC 1160
- GSC 1410L
- STS 2010

Prerequisite Level 2

- CHM 1220/L
Requires CHM 1210/L
- MAT 1150
Requires C or better in MAT 1140 OR minimum score on ALEKS placement test
- PHY 1510/L
Requires MAT 1140 or MAT 1200

Other Courses

- 16 Units Subplan/Option Electives
- 0-8 Units Unrestricted Electives

Prerequisite Level 3

- MAT 2250
Requires MAT 1150
- MAT 2140
Requires MAT 1150
- PHY 1520/L
Requires PHY 1510/L

Prerequisite Level 4

- PHY 2530/A/L
Requires MAT 2140 & PHY 1520/L

Prerequisite Level 5

- PHY 3600/A
Corequisite for PHY 3210
- PHY 3210/A
Requires or Corequisite CS 1260 OR MAT 2010
Corequisite for PHY 3600

Prerequisite Level 6

- PHY 2540/A/L
Requires PHY 3600/A

Prerequisite Level 7

- PHY 4630
Requires PHY 2540/A/L
- PHY 4510W/LW OR PHY 4520W/LW
Requires PHY 2540/A/L